



www.apevibro.com

DEEP FOUNDATION SOLUTIONS

VIBRATORY HAMMERS • POWER UNITS • AUGER SYSTEMS • DIESEL & HYDRAULIC HAMMERS
DRILL RIGS • HYDRAULIC PILING RIGS • WICK DRAIN INSTALLERS • LEAD SYSTEMS



www.jandm-usa.com

APE PIN ON BELL WEIGHT

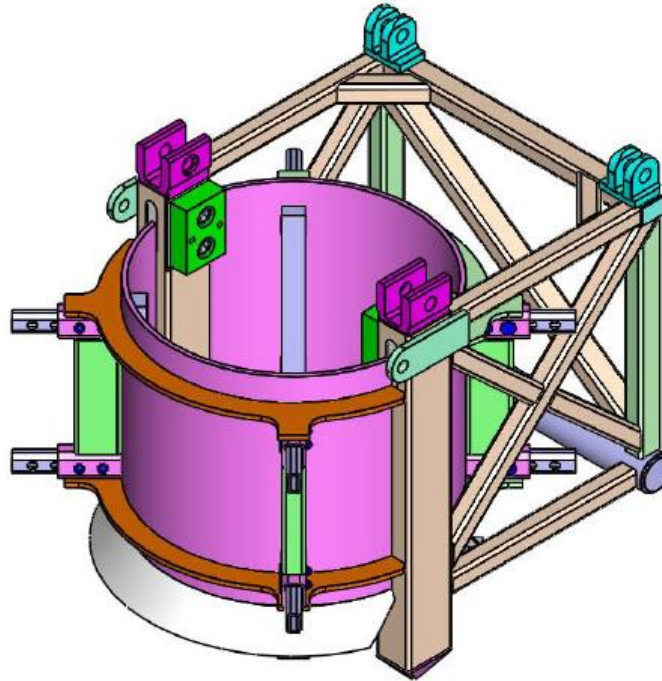

26" BELL = 1,690 LBS

32" BELL = 1,950 LBS

37" BELL = 3,050 LBS

43" BELL = 3,570 LBS

54" BELL = 5,150 LBS

APE Headquarters
Kent, WA
(800) 248-8498 • (253) 872-0141

APE China
Shanghai, China
011-86-21-3677-1221

Gulf Regional Office
Conroe, TX / Gonzales, LA
(832) 724-1044 • (877) 293-4244

APE Canada
Nisku, Alberta, Canada
(780) 474-9888 • (855) 328-9888

APE Mexico
(786) 991-6875

Western Regional Office
Stockton, CA
(888) 245-4401 • (209) 942-2166

Northeast Regional Office
Sayreville, NJ
(888) 217-7524 • (732) 432-6604

Southeast Regional Office
Mulberry, FL
(800) 570-3844 • (863) 324-0378

Mid-Western Regional Office
St. Peters, MO
(855) 303-4580 • (636) 397-8400

Mid-Atlantic Regional Office
Virginia Beach, VA
(866) 399-7500 • (757) 518-9740

APE Piling Products
Magnolia, TX
(936) 372-9760